

MODELO	FA52	
Ø VEIO SAÍDA	35	mm
RÁCIO APROXIMADO	36	
RÁCIO EXATO	35.78	
VELOCIDADE SAÍDA	41	RPM
VELOCIDADE SAÍDA EXATA	41	RPM
POTÊNCIA ENTRADA	1.10	KW
ROTAÇÃO ENTRADA	1400	RPM
PAM ENTRADA	90B5	
TORQUE SAÍDA	257.72	N.m
TORQUE NOMINAL	490.00	N.m
POTÊNCIA NOMINAL	2.1	KW
FATOR SERVIÇO	1.91	
EFICIÊNCIA DINÂMICA	0.96	



QUANTIDADE DE ÓLEO (L)

B3/H1	B6/H4	B7/H3	B8/H2	V5/H5	V6/H6
1.85	1.15	1.15	1.3	2.1	1.3

CARGAS RADIAIS E AXIAIS



n_2 [min-1]	FA [N]	FR [N]
300	400	2000
200	440	2200
120	500	2500
15	1140	5700

PFA52C...

Basic gearbox
Riduttore base

Gearbox weight
peso riduttore **15.5 kg**

M. flanges	Kit code	øF	A
71B5	K023.4.041	160	227
80/90B5	K023.4.042	200	229
100/112B5	K023.4.043	250	238
132B5	KC50.4.043	300	256
80B14	K085.4.046	120	229
90B14	K085.4.045	140	229
100/112B14	K085.4.047	160	238
132B14	KC50.4.041	200	256

● Available torque arms,
see our web site
Bracci di reazione disponibili,
consulta il nostro sito web



Standard
Hollow shaft



On request
A richiesta

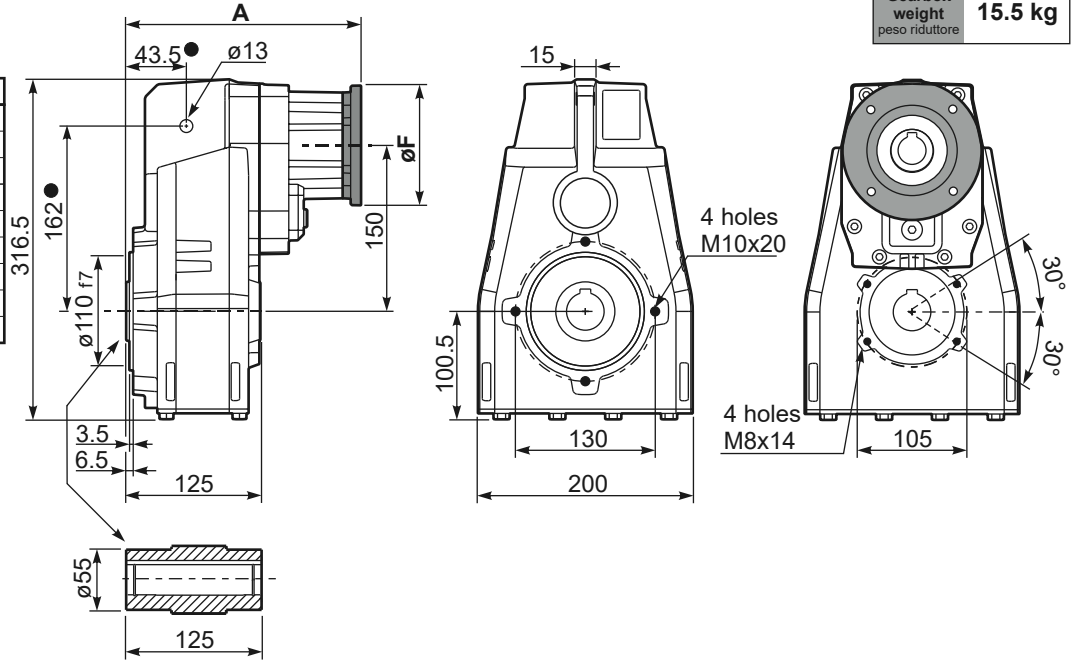

PFA52...-F...

Output flange
Flangia uscita

M. flanges	k1
71B5	260
80/90B5	262
100/112B5	271
132B5	289
80B14	262
90B14	262
100/112B14	271
132B14	289



Available output flanges
Flange di uscita

a1 ø	b1	c1	e1	s1	Kit code
250	180	13	215	14	KF60.9.011
-	-	-	-	-	-

RFA52C...

Input Shaft
Albero in entrata



PFA52 A...

Single output shaft
Albero uscita semplice



PFA52D...

Shrink disk
Calettatore

