

Ficha Técnica
Redutor de Velocidade
PARAFUSO SEM FIM REDONDO



MODELO	030	
Ø VEIO SAÍDA	14	mm
RÁCIO APROXIMADO	40	
RÁCIO EXATO	35.00	
VELOCIDADE SAÍDA	37	RPM
VELOCIDADE SAÍDA EXATA	42	RPM
POTÊNCIA ENTRADA	0.12	KW
ROTAÇÃO ENTRADA	1400	RPM
PAM ENTRADA	63B14	
TORQUE SAÍDA	16.33	N.m
TORQUE NOMINAL	20.00	N.m
POTÊNCIA NOMINAL	0.13	KW
FATOR SERVIÇO	1.08	
EFICIÊNCIA DINÂMICA	0.57	



QUANTIDADE DE ÓLEO (L)

B3/H1	B6/H4	B7/H3	B8/H2	V5/H5	V6/H6
0.03	0.03	0.03	0.03	0.03	0.03

CARGAS RADIAIS E AXIAIS



n_2 [min-1]	FA [N]	FR [N]
200	120	600
100	160	800
50	200	1000
15	280	1400

Universal Motors S.A.
Rua Comendador Brandão, 484
4495-375 Póvoa de Varzim
geral@universalmotors.pt
TEL.: 252 299 080

Universal Motors UK, Ltd
Unit E2, Meltham Mills Road
West Yorkshire HD9 4AR
enquiries@universalmotors-group.co.uk
TEL.: +44(0) 1484660222

Universal Motors SL
C/La Habana n.6 nave 4 Pl Camporroso
28806 Alcala de Henares
info@universalmotors-group.es
TEL.: 918 864 213

P030**FB**... Basic wormbox
Riduttore base

Gearbox weight
peso riduttore **1.05 kg**

M. flanges	Kit code	øF	A
56B5	K030.4.041	120	61.5
63B5	K030.4.042	140	62.5
56B14	K030.4.046	80	61.5
63B14	K030.4.045	90	62.5

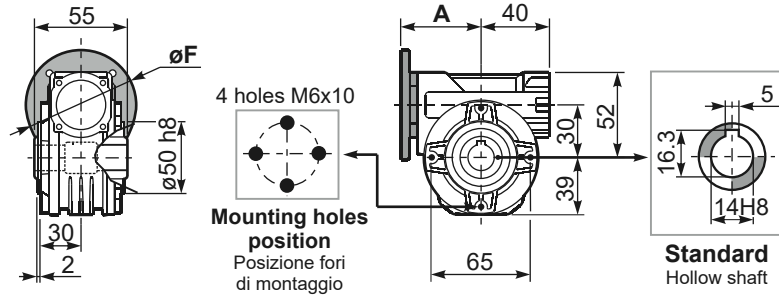

P030**PA**... Feet
Piedini

P030**PB**... Feet
Piedini

P030**PV**... Feet
Piedini

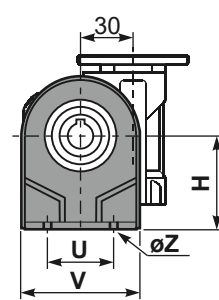
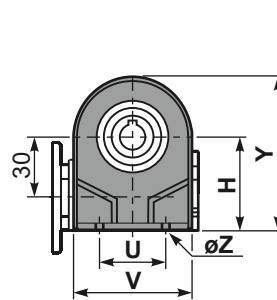
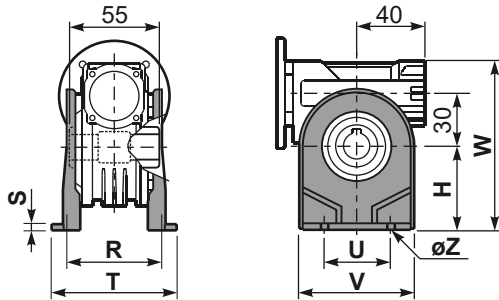

	H	R	S	T	U	V	Y	W	øZ	kit code
type B	55	66	3	87	50	78	94	107	ø6.5	K030.9.022
type S	52	66	3	87	52	90	91	104	ø6.5	KS030.9.023

P030**FC**... Output flange
Flangia uscita

P030**BR**... Reaction arm
Braccio di reazione

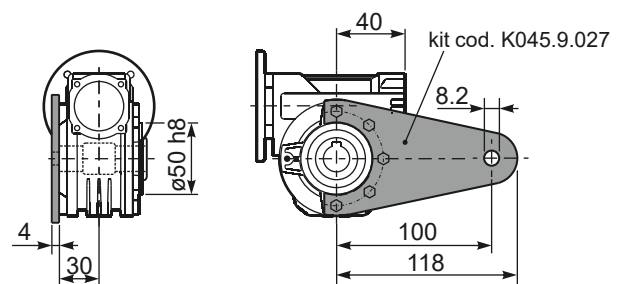
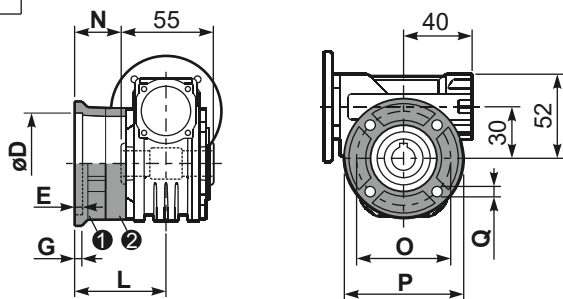

type B	øD	E	G	L	N	O	P	Q	kit code
FC	50 ^{+0.15} / _{+0.05}	6	6	50.5	23	68	80	7	① K030.9.010 ② -
FL	60 ^{+0.15} / _{+0.05}	6	6	55.5	28	87	110	8.5	① K045.9.010 ② -

type S	øD	E	G	L	N	O	P	Q	kit code
F1	40 ^{+0.15} / _{+0.10}	3.5	5.5	49	21.5	56	80	6.5	① KS030.9.012 ② -

P030.....**S**... Single Shaft
Albero lento semplice

P030.....**D**... Double Shaft
Albero lento bisp.

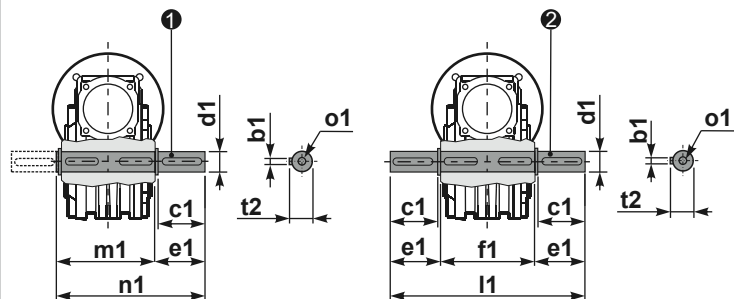

① kit cod. K030.5.028 type B ② kit cod. K030.5.029 type B

R030**FB**... Input shaft
Albero in entrata

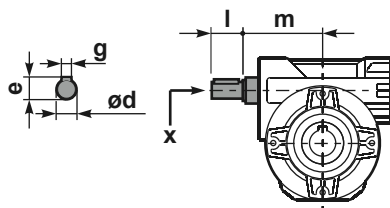

	ød	e	g	l	m	x	kit code
type B	9 h6	10.2	3	20	58	-	K030.5.006 PAM63
type S	-	-	-	-	-	-	-

	b1	c1	d1	e1	f1	l1	m1	n1	t2	o1
type B	5	25	14 ^{-0.005} / _{-0.020}	35.5	55	126	59	94.5	16	M5x14
type S	-	-	-	-	-	-	-	-	-	-