

Ficha Técnica  
Redutor de Velocidade  
PARAFUSO SEM FIM REDONDO



MODELO	050	
Ø VEIO SAÍDA	25	mm
RÁCIO APROXIMADO	70	
RÁCIO EXATO	68.00	
VELOCIDADE SAÍDA	21	RPM
VELOCIDADE SAÍDA EXATA	21	RPM
POTÊNCIA ENTRADA	0.18	KW
ROTAÇÃO ENTRADA	1400	RPM
PAM ENTRADA	63B14	
TORQUE SAÍDA	47.59	N.m
TORQUE NOMINAL	58.00	N.m
POTÊNCIA NOMINAL	0.22	KW
FATOR SERVIÇO	1.22	
EFICIÊNCIA DINÂMICA	0.57	



QUANTIDADE DE ÓLEO (L)

B3/H1	B6/H4	B7/H3	B8/H2	V5/H5	V6/H6
0.14	0.14	0.14	0.14	0.14	0.14

CARGAS RADIAIS E AXIAIS



$n_2$ [min-1]	FA [N]	FR [N]
200	240	1200
100	300	1500
50	380	1900
15	560	2800

Universal Motors S.A.  
Rua Comendador Brandão, 484  
4495-375 Póvoa de Varzim  
[geral@universalmotors.pt](mailto:geral@universalmotors.pt)  
TEL.: 252 299 080

Universal Motors UK, Ltd  
Unit E2, Meltham Mills Road  
West Yorkshire HD9 4AR  
[enquiries@universalmotors-group.co.uk](mailto:enquiries@universalmotors-group.co.uk)  
TEL.: +44(0) 1484660222

Universal Motors SL  
C/La Habana n.6 nave 4 Pl Camporroso  
28806 Alcalá de Henares  
[info@universalmotors-group.es](mailto:info@universalmotors-group.es)  
TEL.: 918 864 213

**P050FB...** Basic wormbox  
Riduttore base

Gearbox weight  
peso riduttore **3.00 kg**

M. flanges	Kit code	øF	A
<b>63B5</b>	K050.4.041	138	78.5
<b>71B5</b>	K050.4.042	160	76
<b>80B5</b>	K050.4.043	200	76.5
<b>56B14</b>	KC40.4.049	80	76
<b>63B14</b>	K050.4.047	90	78.5
<b>71B14</b>	K050.4.045	105	76
<b>80B14</b>	K050.4.046	120	76.5



**P050PA...** Feet  
Piedini

**P050PB...** Feet  
Piedini

**P050PV...** Feet  
Piedini



	H	R	S	T	U	V	Y	W	øZ	kit code
type B	82	98.5	3.5	123	63	113	138.5	163	ø10.5	K050.9.022
type S	85	96	10	114	85	110	139.5	166	ø10	KS050.9.023

**P050FC...** Output flange  
Flangia uscita

**P050BR...** Reaction arm  
Braccio di reazione

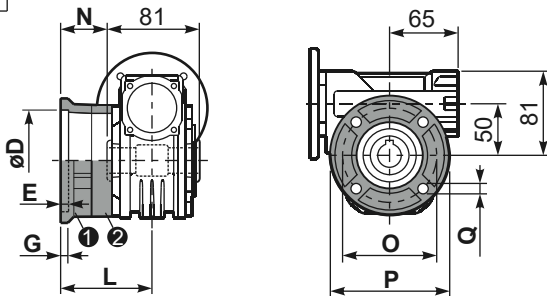

type B	øD	E	G	L	N	O	P	Q	kit code
<b>FC</b>	70 <sup>+0.20</sup> / <sub>+0.15</sub>	9	12	85	44.5	90	123	10.5	① K050.9.010 ② -
<b>FL</b>	70 <sup>+0.20</sup> / <sub>+0.15</sub>	9	12	114.5	74	90	123	10.5	① K050.9.010 ② K050.0.200
type S	øD	E	G	L	N	O	P	Q	kit code
<b>F1</b>	110 <sup>+0.20</sup> / <sub>+0.15</sub>	4	11	83.5	43	130	160	10	① KS050.9.012 ② -
<b>F2</b>	70 <sup>+0.20</sup> / <sub>+0.15</sub>	9	12	76.5	36	90	123	10.5	① KS050.9.014 ② -
<b>F3</b>	95 <sup>+0.035</sup> / <sub>0</sub>	4	10	66.5	26	115	140	10	① KS050.9.013 ② -

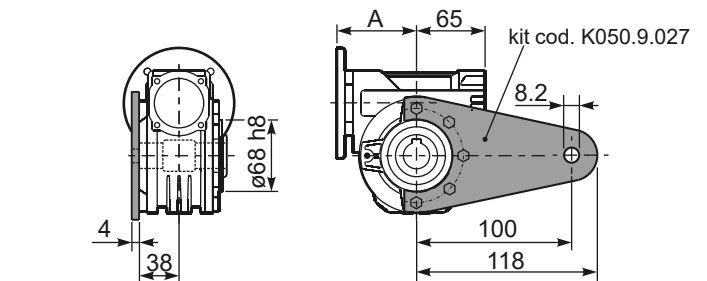

**P050.....S...** Single Shaft  
Albero lento semplice

**P050.....D...** Double Shaft  
Albero lento bisp.

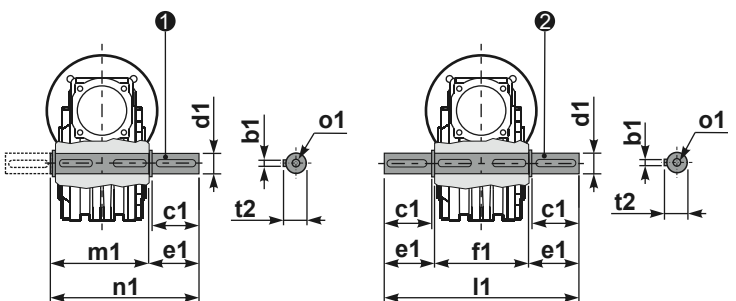

① kit cod. K050.5.028 type B  
kit cod. KS050.5.030 type S

② kit cod. K050.5.029 type B

**R050FB...** Input shaft  
Albero in entrata



	ød	e	g	l	m	x	kit code
type B	16 h6	18	5	30	74.5	M6x16	① K050.5.006 PAM71 ② K050.5.007 PAM80
type S	14 h6	16	5	30	74.5	M5x10	① KS050.5.008 PAM71 ② KS050.5.009 PAM80

	b1	c1	d1	e1	f1	l1	m1	n1	t2	o1
type B	8	52	25 <sup>-0.005</sup> / <sub>-0.020</sub>	59.5	81	200	86.5	146	28	M8x20
type S	8	50	24 <sup>-0.005</sup> / <sub>-0.020</sub>	68.8	-	-	86.5	155	27	M8x20