

Ficha Técnica
Redutor de Velocidade
PARAFUSO SEM FIM REDONDO



MODELO	050	
Ø VEIO SAÍDA	25	mm
RÁCIO APROXIMADO	70	
RÁCIO EXATO	68.00	
VELOCIDADE SAÍDA	21	RPM
VELOCIDADE SAÍDA EXATA	21	RPM
POTÊNCIA ENTRADA	0.25	KW
ROTAÇÃO ENTRADA	1400	RPM
PAM ENTRADA	71B14	
TORQUE SAÍDA	66.09	N.m
TORQUE NOMINAL	58.00	N.m
POTÊNCIA NOMINAL	0.22	KW
FATOR SERVIÇO	0.88	
EFICIÊNCIA DINÂMICA	0.57	



QUANTIDADE DE ÓLEO (L)

B3/H1	B6/H4	B7/H3	B8/H2	V5/H5	V6/H6
0.14	0.14	0.14	0.14	0.14	0.14

CARGAS RADIAIS E AXIAIS



n_2 [min-1]	FA [N]	FR [N]
200	240	1200
100	300	1500
50	380	1900
15	560	2800

Universal Motors S.A.
Rua Comendador Brandão, 484
4495-375 Póvoa de Varzim
geral@universalmotors.pt
TEL.: 252 299 080

Universal Motors UK, Ltd
Unit E2, Meltham Mills Road
West Yorkshire HD9 4AR
enquiries@universalmotors-group.co.uk
TEL.: +44(0) 1484660222

Universal Motors SL
C/La Habana n.6 nave 4 Pl Camporoso
28806 Alcala de Henares
info@universalmotors-group.es
TEL.: 918 864 213

P050FB... Basic wormbox
Riduttore base

Gearbox weight
peso riduttore **3.00 kg**

M. flanges	Kit code	øF	A
63B5	K050.4.041	138	78.5
71B5	K050.4.042	160	76
80B5	K050.4.043	200	76.5
56B14	KC40.4.049	80	76
63B14	K050.4.047	90	78.5
71B14	K050.4.045	105	76
80B14	K050.4.046	120	76.5



4 holes M6x9

Mounting holes position
Posizione fori di montaggio



Standard
Hollow shaft

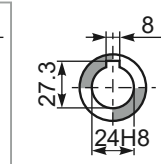

On request "type S"
A richiesta "tipo S"

P050PA... Feet
Piedini

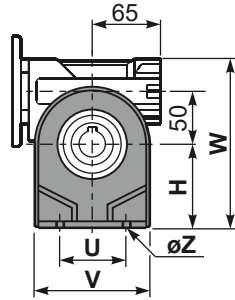
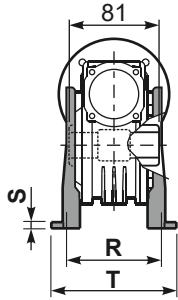

P050PB... Feet
Piedini

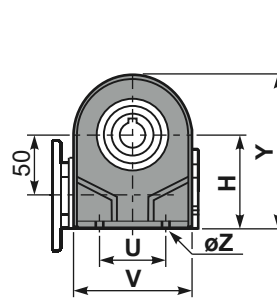

P050PV... Feet
Piedini

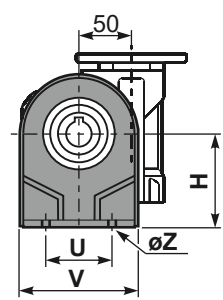

	H	R	S	T	U	V	Y	W	øZ	kit code
type B	82	98.5	3.5	123	63	113	138.5	163	ø10.5	K050.9.022
type S	85	96	10	114	85	110	139.5	166	ø10	KS050.9.023

P050FC... Output flange
Flangia uscita

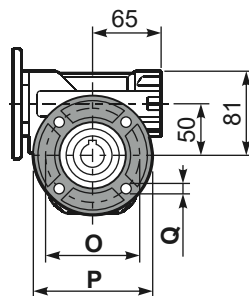

type B	øD	E	G	L	N	O	P	Q	kit code
FC	70 ^{+0.20} / _{+0.15}	9	12	85	44.5	90	123	10.5	1 K050.9.010 2 -
FL	70 ^{+0.20} / _{+0.15}	9	12	114.5	74	90	123	10.5	1 K050.9.010 2 K050.0.200
type S	øD	E	G	L	N	O	P	Q	kit code
F1	110 ^{+0.20} / _{+0.15}	4	11	83.5	43	130	160	10	1 KS050.9.012 2 -
F2	70 ^{+0.20} / _{+0.15}	9	12	76.5	36	90	123	10.5	1 KS050.9.014 2 -
F3	95 ^{+0.035} / ₀	4	10	66.5	26	115	140	10	1 KS050.9.013 2 -

P050BR... Reaction arm
Braccio di reazione



P050.....S... Single Shaft
Albero lento semplice

P050.....D... Double Shaft
Albero lento bisp.

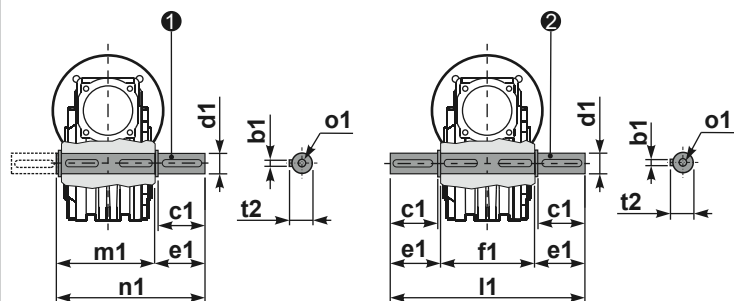

1 kit cod. K050.5.028 type B
kit cod. KS050.5.030 type S

2 kit cod. K050.5.029 type B

R050FB... Input shaft
Albero in entrata

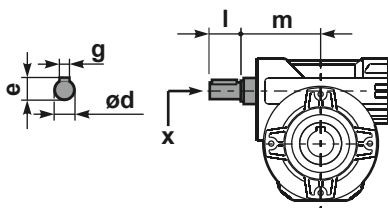

	ød	e	g	l	m	x	kit code
type B	16 h6	18	5	30	74.5	M6x16	1 K050.5.006 PAM71 2 K050.5.007 PAM80
type S	14 h6	16	5	30	74.5	M5x10	1 KS050.5.008 PAM71 2 KS050.5.009 PAM80

	b1	c1	d1	e1	f1	l1	m1	n1	t2	o1
type B	8	52	25 ^{-0.005} / _{-0.020}	59.5	81	200	86.5	146	28	M8x20
type S	8	50	24 ^{-0.005} / _{-0.020}	68.8	-	-	86.5	155	27	M8x20