

Ficha Técnica  
Redutor de Velocidade  
PARAFUSO SEM FIM REDONDO



MODELO	085	
Ø VEIO SAÍDA	35	mm
RÁCIO APROXIMADO	30	
RÁCIO EXATO	28.00	
VELOCIDADE SAÍDA	49	RPM
VELOCIDADE SAÍDA EXATA	52	RPM
POTÊNCIA ENTRADA	1.10	KW
ROTAÇÃO ENTRADA	1400	RPM
PAM ENTRADA	90B5	
TORQUE SAÍDA	157.56	N.m
TORQUE NOMINAL	347.00	N.m
POTÊNCIA NOMINAL	2.4	KW
FATOR SERVIÇO	2.18	
EFICIÊNCIA DINÂMICA	0.75	



QUANTIDADE DE ÓLEO (L)

B3/H1	B6/H4	B7/H3	B8/H2	V5/H5	V6/H6
1.2	1.2	1.2	1.2	1.2	1.2

CARGAS RADIAIS E AXIAIS



$n_2$ [min-1]	FA [N]	FR [N]
200	500	2500
100	600	3000
50	800	4000
15	1160	5800

Universal Motors S.A.  
Rua Comendador Brandão, 484  
4495-375 Póvoa de Varzim  
[geral@universalmotors.pt](mailto:geral@universalmotors.pt)  
TEL.: 252 299 080

Universal Motors UK, Ltd  
Unit E2, Meltham Mills Road  
West Yorkshire HD9 4AR  
[enquiries@universalmotors-group.co.uk](mailto:enquiries@universalmotors-group.co.uk)  
TEL.: +44(0) 1484660222

Universal Motors SL  
C/La Habana n.6 nave 4 PI Camporosso  
28806 Alcala de Henares  
[info@universalmotors-group.es](mailto:info@universalmotors-group.es)  
TEL.: 918 864 213

**P085FB...** Basic wormbox  
Riduttore base

Gearbox weight  
peso riduttore **11.00 kg**

M. flanges	Kit code	øF	A
<b>71B5</b>	K023.4.041	160	116.5
<b>80/90B5</b>	K023.4.042	200	118.5
<b>100/112B5</b>	K023.4.043	250	127.5
<b>80B14</b>	K085.4.046	120	118.5
<b>90B14</b>	K085.4.045	140	118.5
<b>100/112B14</b>	K085.4.047	160	127.5



**P085PA...** Feet  
Piedini

**P085PB...** Feet  
Piedini

**P085PV...** Feet  
Piedini



	H	R	S	T	U	V	Y	W	øZ	kit code
type B	142	145	5	182	140	180	236.5	280	ø10.5	K085.9.022
type S	-	-	-	-	-	-	-	-	-	-

**P085FC...** Output flange  
Flangia uscita

**P085BR...** Reaction arm  
Braccio di reazione

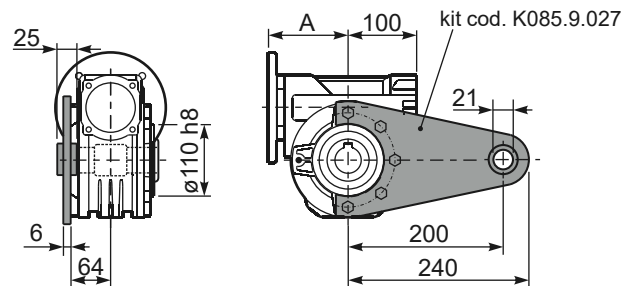

type B	øD	E	G	L	N	O	P	Q	kit code
<b>FC</b>	152 <sup>+0.06</sup> / <sub>+0.00</sub>	5	16	108	40.5	176	205	13	① K085.9.010 ② -
<b>FL</b>	152 <sup>+0.06</sup> / <sub>+0.00</sub>	5	16	148.5	81	176	205	13	① K085.9.010 ② K085.0.201
type S	øD	E	G	L	N	O	P	Q	kit code
<b>F1</b>	130 H7	5	13	117.5	50	165	200	11.5	① KS085.9.012 ② -
<b>F2</b>	152 <sup>+0.06</sup> / <sub>+0.00</sub>	5	15	147.5	80	180	205	12.5	① KS085.9.013 ② -
<b>F4</b>	130 H7	5	13	106.5	39	165	200	13	① KS085.9.015 ② -

**P085.....S...** Single Shaft  
Albero lento semplice

**P085.....D...** Double Shaft  
Albero lento bisp.

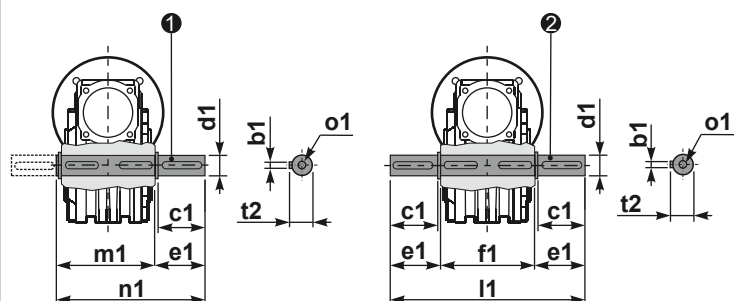

① kit cod. K085.5.028 type B    ② kit cod. K085.5.029 type B

**R085FB...** Input shaft  
Albero in entrata



	ød	e	g	l	m	x	kit code
type B	25 h6	28	8	50	112	M8x20	① K085.5.007 PAM90 ② K085.5.008 PAM100
type S	24 h6	27	8	50	112	M8x20	① KS085.5.009 PAM90 ② KS085.5.011 PAM100

	b1	c1	d1	e1	f1	l1	m1	n1	t2	o1
type B	10	60	35 <sup>-0.005</sup> / <sub>-0.020</sub>	73.5	135	282	141	214.5	38	M10x23
type S	-	-	-	-	-	-	-	-	-	-