

MODELO	311A
Ø VEIO SAÍDA	14 mm
RÁCIO APROXIMADO	3.5
RÁCIO EXATO	3.29
VELOCIDADE SAÍDA	417 RPM
VELOCIDADE SAÍDA EXATA	444 RPM
POTÊNCIA ENTRADA	0.25 KW
ROTAÇÃO ENTRADA	1400 RPM
PAM ENTRADA	71B5
TORQUE SAÍDA	5.16 N.m
TORQUE NOMINAL	26.00 N.m
POTÊNCIA NOMINAL	1.2 KW
FATOR SERVIÇO	4.80
EFICIÊNCIA DINÂMICA	0.92

QUANTIDADE DE ÓLEO (L)

B3/H1	B6/H4	B7/H3	B8/H2	V5/H5	V6/H6
0.1	0.1	0.1	0.1	0.1	0.1

CARGAS RADIAIS E AXIAIS



n_2 [min-1]	FA [N]	FR [N]
700	120	640
400	160	800
200	200	1020
140	225	1120

P311-F... Output flange
flange di uscita

Gearbox weight
peso riduttore **2.50 kg**

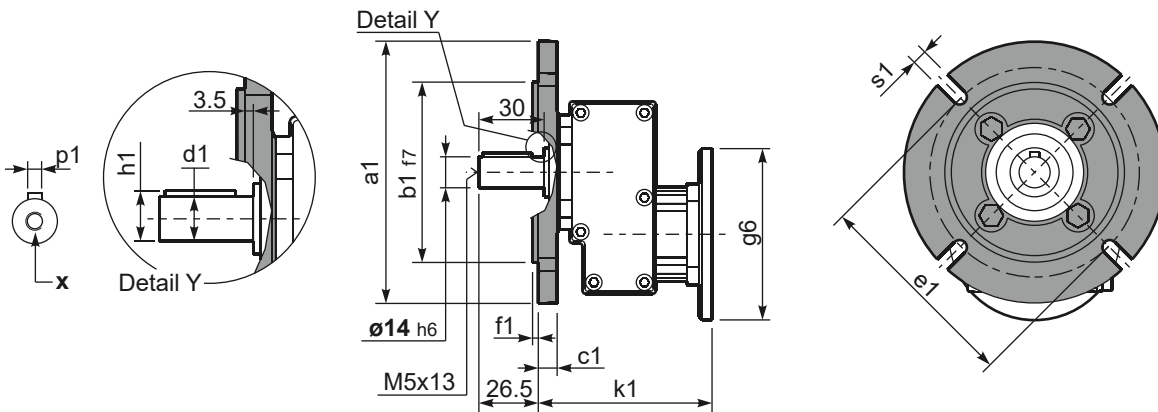

***Available output shaft / Albero di uscita**

	Shaft - d1	p1	h1	x
Standard	ø 14x30	5	16	M5x13
On request A richiesta	ø 19x40 ø 24x40	6 8	21.5 27	M6x16 M6x16

Available output flanges / flange di uscita

a1 ø	b1	c1	e1	f1	s1	kit code
120	80	11.5	100	3	9*	KC30.9.010
140	95	11.5	115	3	9	KC30.9.011
160	110	11.5	130	3.5	9	KC30.9.012
200	130	11.5	165	3.5	11	KC30.9.013

*Holes position
posizione fori

P311-H1... With feet
Con piedini



R311-N... Input Shaft
Albero in entrata



P311-N... Basic gearbox
Riduttore base



B14 Motor Flanges	A	g6	k1	kit code
56 B14	103	80	106.5	KC40.4.049
63 B14	105.5	90	109	K050.4.047
71 B14	103	105	106.5	K050.4.045

B5 Motor Flanges	A	g6	k1	kit code
63 B5	105.5	138	109	K050.4.041
71 B5	103	160	106.5	K050.4.042