

MODELO	613A
Ø VEIO SAÍDA	35 mm
RÁCIO APROXIMADO	241
RÁCIO EXATO	241.82
VELOCIDADE SAÍDA	6 RPM
VELOCIDADE SAÍDA EXATA	6 RPM
POTÊNCIA ENTRADA	0.12 KW
ROTAÇÃO ENTRADA	1400 RPM
PAM ENTRADA	63B5
TORQUE SAÍDA	186.06 N.m
TORQUE NOMINAL	440.00 N.m
POTÊNCIA NOMINAL	0.28 KW
FATOR SERVIÇO	2.33
EFICIÊNCIA DINÂMICA	0.94

#### QUANTIDADE DE ÓLEO (L)

B3/H1	B6/H4	B7/H3	B8/H2	V5/H5	V6/H6
1.05	1.1	1.25	1.25	1.35	1.5

#### CARGAS RADIAIS E AXIAIS



$n_2$ [min-1]	FA [N]	FR [N]
300	560	2800
200	640	3200
120	760	3800
15	1300	6500

P613A **B1** ... With feet  
Con piedini

Gearbox weight **14.3 kg**  
peso riduttore With flange  
With feet **14.7 Kg**



**Feet / piedini**

Feet Code	Market reference	G	H	R	L	S	H1	O	øl	S2 only with motor flange	B5 max. Flange	kit code
<b>B4</b>	412/3	20	130	180	149.5	216	242	18	14	-	-	KC60.9.024
<b>S4</b>	47-57	30	115	135	165	170	227	25	14	13 132B5	-	KC50.9.022
<b>M3</b>	62/3	35	120	170-185	110	230	232	20	14	8 132B5	-	KC60.9.023
<b>S7</b>	77	35	140	170	205	204	252	8	14	-	-	KC60.9.029LM
<b>H4</b>	024-243	35	155	170	150	225	267	30	14	-	-	KC60.9.025

Other feet are available, see our web site  
Sono disponibili altri piedini, consulta il nostro sito web

**A see on page bottom**

Most popular types  
Tipi più diffusi

P613A-**F** ... Output flanges  
flange di uscita



\*Available output shaft / Albero di uscita

	Shaft - d1	p1	h1	x
Standard	ø 35x70	10	38	M10x22
On request A richiesta	ø 28x60	8	31	M8x20
	ø 30x60	8	33	M10x22
	ø 38x70	10	41	M10x25
	ø 40x80	12	43	M12x28

Available output flanges / flange di uscita

a1 ø	b1	c1	e1	f1	s1	kit code
160	110	14	130	3.5	11	KC50.9.011
200	130	13	164	3.5	11	KC50.9.012
250	180	15.5	215	4	14	KC50.9.013

With flange and feet only on request.  
Ask for compatibility

P613A-**N** ... Basic gearbox  
Riduttore base

**R613A-N** ... Input Shaft  
Albero in entrata

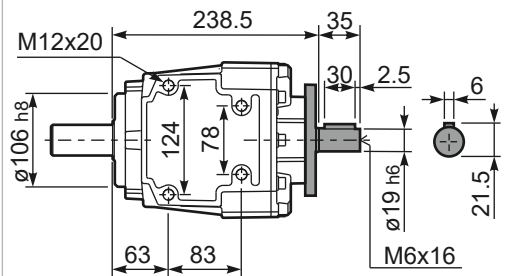
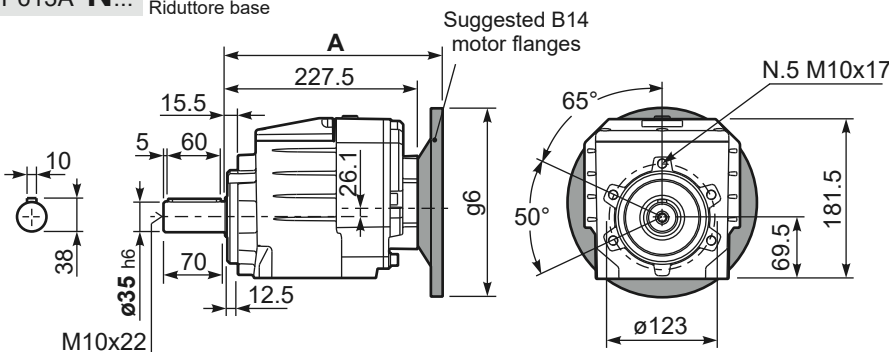

B5 Motor Flanges	A	C <sub>max</sub>	g6	k1	kit code	k1 with KC50.9.011
63 B5	248	251.1	140	250.5	K063.4.041	256.5
71 B5	246	261.1	160	248.5	K063.4.042	254.5
80/90 B5	248	281.1	200	250.5	K063.4.043	256.5

B14 Motor Flanges	A	C <sub>max</sub>	g6	k1	kit code	k1 with KC50.9.011
71 B14	246	233.6	105	248.5	K063.4.047	254.5
80 B14	248	241.1	120	250.5	K063.4.046	256.5
90 B14	248	251.1	140	250.5	K063.4.041	256.5