

MODELO	613A	
Ø VEIO SAÍDA	35	mm
RÁCIO APROXIMADO	364	
RÁCIO EXATO	363.63	
VELOCIDADE SAÍDA	4	RPM
VELOCIDADE SAÍDA EXATA	4	RPM
POTÊNCIA ENTRADA	0.12	KW
ROTAÇÃO ENTRADA	1400	RPM
PAM ENTRADA	63B5	
TORQUE SAÍDA	279.78	N.m
TORQUE NOMINAL	435.00	N.m
POTÊNCIA NOMINAL	0.19	KW
FATOR SERVIÇO	1.58	
EFICIÊNCIA DINÂMICA	0.94	

QUANTIDADE DE ÓLEO (L)

B3/H1	B6/H4	B7/H3	B8/H2	V5/H5	V6/H6
1.05	1.1	1.25	1.25	1.35	1.5

CARGAS RADIAIS E AXIAIS



$n_2$ [min-1]	$F_A$ [N]	$F_R$ [N]
300	560	2800
200	640	3200
120	760	3800
15	1300	6500

P613A **B1** ... With feet  
Con piedini

Gearbox weight **14.3 kg**  
peso riduttore With flange  
With feet **14.7 Kg**

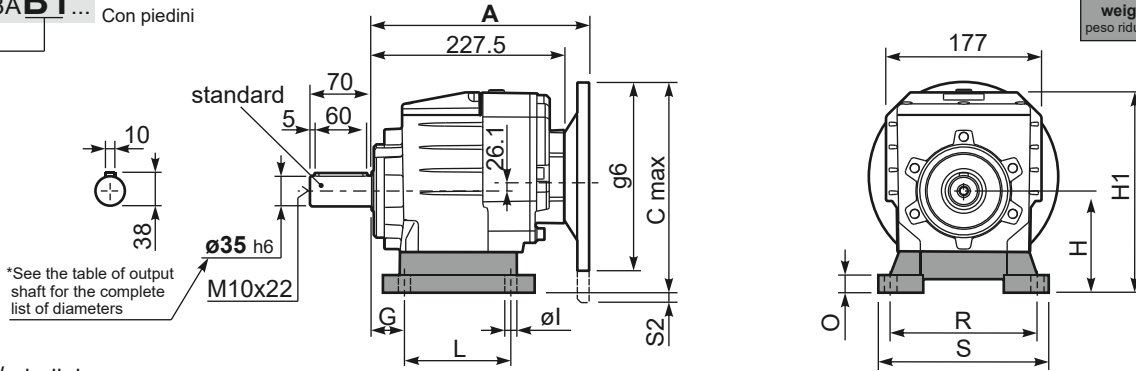

**Feet / piedini**

Feet Code	Market reference	G	H	R	L	S	H1	O	øl	S2 only with motor flange	B5 max. Flange	kit code
<b>B4</b>	412/3	20	130	180	149.5	216	242	18	14	-	-	KC60.9.024
<b>S4</b>	47-57	30	115	135	165	170	227	25	14	13 132B5	-	KC50.9.022
<b>M3</b>	62/3	35	120	170-185	110	230	232	20	14	8 132B5	-	KC60.9.023
<b>S7</b>	77	35	140	170	205	204	252	8	14	-	-	KC60.9.029LM
<b>H4</b>	024-243	35	155	170	150	225	267	30	14	-	-	KC60.9.025

Other feet are available, see our web site  
Sono disponibili altri piedini, consulta il nostro sito web

**A see on page bottom**

Most popular types  
Tipi più diffusi

P613A-**F** ... Output flanges  
flange di uscita

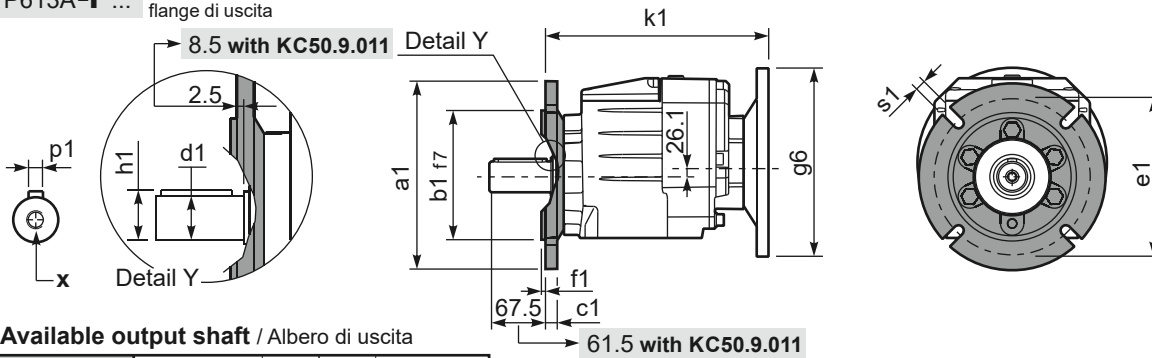

\*Available output shaft / Albero di uscita

	Shaft - d1	p1	h1	x
Standard	ø 35x70	10	38	M10x22
On request A richiesta	ø 28x60	8	31	M8x20
	ø 30x60	8	33	M10x22
	ø 38x70	10	41	M10x25
	ø 40x80	12	43	M12x28

Available output flanges / flange di uscita

a1 ø	b1	c1	e1	f1	s1	kit code
160	110	14	130	3.5	11	KC50.9.011
200	130	13	164	3.5	11	KC50.9.012
250	180	15.5	215	4	14	KC50.9.013

With flange and feet only on request.  
Ask for compatibility

P613A-**N** ... Basic gearbox  
Riduttore base

**R613A-N** ... Input Shaft  
Albero in entrata

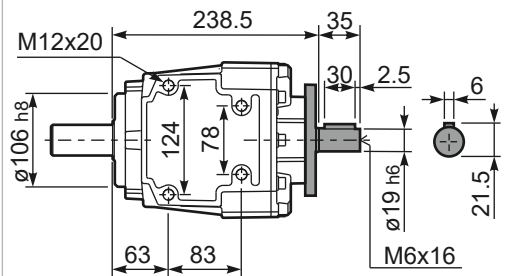

B5 Motor Flanges	A	C <sub>max</sub>	g6	k1	kit code	k1 with KC50.9.011
63 B5	248	251.1	140	250.5	K063.4.041	256.5
71 B5	246	261.1	160	248.5	K063.4.042	254.5
80/90 B5	248	281.1	200	250.5	K063.4.043	256.5

B14 Motor Flanges	A	C <sub>max</sub>	g6	k1	kit code	k1 with KC50.9.011
71 B14	246	233.6	105	248.5	K063.4.047	254.5
80 B14	248	241.1	120	250.5	K063.4.046	256.5
90 B14	248	251.1	140	250.5	K063.4.041	256.5