

MODELO	UMSG30	
Ø VEIO SAÍDA	14	mm
RÁCIO APROXIMADO	40	
RÁCIO EXATO	40.00	
VELOCIDADE SAÍDA	37	RPM
VELOCIDADE SAÍDA EXATA	37	RPM
POTÊNCIA ENTRADA	0.09	KW
ROTAÇÃO ENTRADA	1400	RPM
PAM ENTRADA	56B14	
TORQUE SAÍDA	14.49	N.m
TORQUE NOMINAL	17.71	N.m
POTÊNCIA NOMINAL	0.11	KW
FATOR SERVIÇO	1.22	
EFICIÊNCIA DINÂMICA	0.59	



QUANTIDADE DE ÓLEO (L)

B3/H1	B6/H4	B7/H3	B8/H2	V5/H5	V6/H6
0.05	0.05	0.05	0.05	0.05	0.05

CARGAS RADIAIS E AXIAIS



n_2 [min ⁻¹]	FA [N]	FR [N]
200	120	600
100	160	800
50	200	1000
15	280	1400

Basic wormbox



Square flange FA



Single Shaft

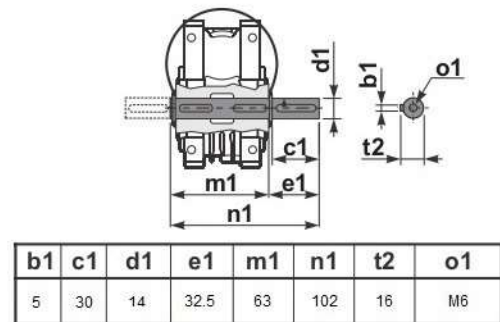

Feet

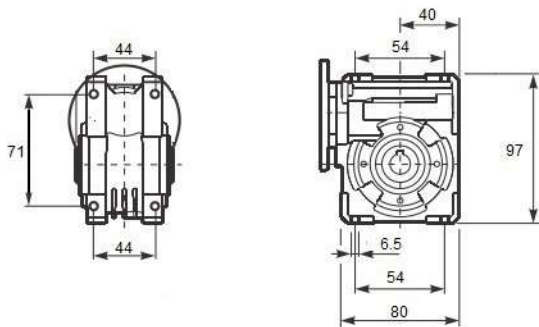

Reaction arm

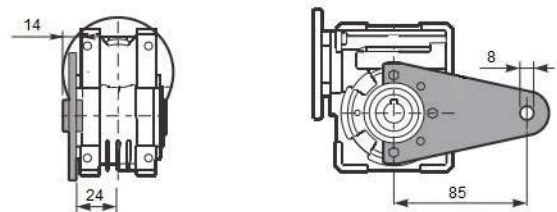

1400 rpm	N2	Relação	P1	FS	P1n	M2	Rend.	Fr max	Veio		Flanges de entrada	
	rpm	i	kW		kW	Nm	%	N	Entrada	Saída	56	63
UMSG30	187	7,5	0,25	1,6	0,41	18	0,85	683	11	14	B14/B5	B14/B5
	140	10	0,25	1,3	0,32	18	0,82	752			B14/B5	B14/B5
	93	15	0,25	0,9	0,23	18	0,77	861			B14/B5	B14/B5
	70	20	0,18	1,0	0,18	18	0,73	948			B14/B5	B14/B5
	56	25	0,18	1,0	0,18	20	0,68	1021			B14/B5	B14/B5
	47	30	0,18	0,8	0,15	20	0,65	1085			B14/B5	B14/B5
	35	40	0,12	0,9	0,11	18	0,59	1194			B14/B5	B14/B5
	28	50	0,09	1,0	0,09	17	0,55	1286			B14/B5	B14/B5
	23	60	0,09	0,9	0,08	16	0,51	1367			B14/B5	
	18	80	0,06	0,8	0,05	12	0,44	1504			B14/B5	