

MODELO	UMSG150	
Ø VEIO SAÍDA	50	mm
RÁCIO APROXIMADO	25	
RÁCIO EXATO	25.00	
VELOCIDADE SAÍDA	58	RPM
VELOCIDADE SAÍDA EXATA	58	RPM
POTÊNCIA ENTRADA	9.19	KW
ROTAÇÃO ENTRADA	1400	RPM
PAM ENTRADA	132B5	
TORQUE SAÍDA	1317.80	N.m
TORQUE NOMINAL	1145.92	N.m
POTÊNCIA NOMINAL	8	KW
FATOR SERVIÇO	0.87	
EFICIÊNCIA DINÂMICA	0.84	



QUANTIDADE DE ÓLEO (L)

B3/H1	B6/H4	B7/H3	B8/H2	V5/H5	V6/H6
7	5.1	5.1	5.4	7	5.1

CARGAS RADIAIS E AXIAIS



n_2 [min ⁻¹]	FA [N]	FR [N]
200	1300	6500
100	1640	8200
50	2120	10600
15	3300	16500

Basic wormbox



Square flange FA



Single Shaft



b1	c1	d1	e1	m1	n1	t2	o1
14	82	50	87	200	297	53.5	M16

Feet

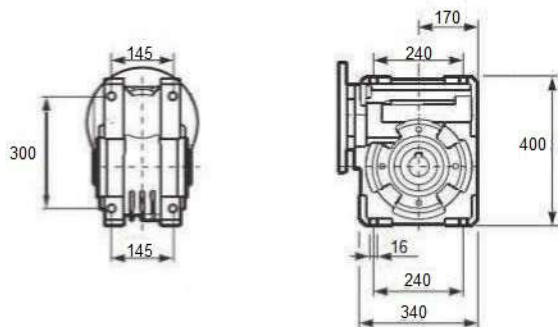

Reaction arm

