

MODELO	UMSG150	
Ø VEIO SAÍDA	50	mm
RÁCIO APROXIMADO	50	
RÁCIO EXATO	50.00	
VELOCIDADE SAÍDA	29	RPM
VELOCIDADE SAÍDA EXATA	29	RPM
POTÊNCIA ENTRADA	3.00	KW
ROTAÇÃO ENTRADA	1400	RPM
PAM ENTRADA	100B5	
TORQUE SAÍDA	777.59	N.m
TORQUE NOMINAL	1425.57	N.m
POTÊNCIA NOMINAL	5.5	KW
FATOR SERVIÇO	1.83	
EFICIÊNCIA DINÂMICA	0.76	



QUANTIDADE DE ÓLEO (L)

B3/H1	B6/H4	B7/H3	B8/H2	V5/H5	V6/H6
7	5.1	5.1	5.4	7	5.1

CARGAS RADIAIS E AXIAIS



n_2 [min ⁻¹]	FA [N]	FR [N]
200	1300	6500
100	1640	8200
50	2120	10600
15	3300	16500

Basic wormbox



Square flange FA



Single Shaft

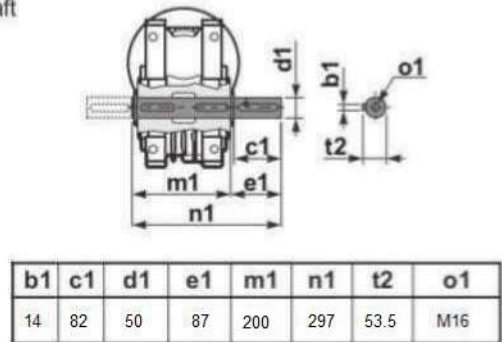

Feet

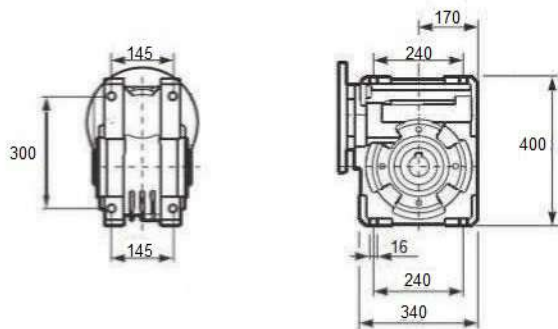

Reaction arm

