

Ficha Técnica
 Redutor de Velocidade
 PARAFUSO SEM FIM QUADRADO

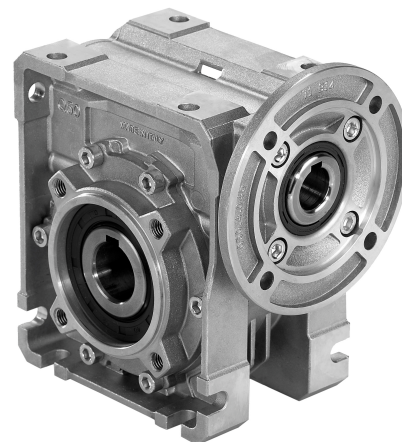

MODELO	Q63	
Ø VEIO SAÍDA	25	mm
RÁCIO APROXIMADO	15	
RÁCIO EXATO	15.00	
VELOCIDADE SAÍDA	97	RPM
VELOCIDADE SAÍDA EXATA	97	RPM
POTÊNCIA ENTRADA	0.75	KW
ROTAÇÃO ENTRADA	1400	RPM
PAM ENTRADA	80B5	
TORQUE SAÍDA	60.62	N.m
TORQUE NOMINAL	138.00	N.m
POTÊNCIA NOMINAL	1.7	KW
FATOR SERVIÇO	2.27	
EFICIÊNCIA DINÂMICA	0.79	



QUANTIDADE DE ÓLEO (L)

B3/H1	B6/H4	B7/H3	B8/H2	V5/H5	V6/H6
0.3	0.3	0.3	0.3	0.3	0.3

CARGAS RADIAIS E AXIAIS



n_2 [min ⁻¹]	FA [N]	FR [N]
200	360	1800
100	460	2300
50	600	3000
15	800	4000

Universal Motors S.A.
 Rua Comendador Brandão, 484
 4495-375 Póvoa de Varzim
geral@universalmotors.pt
 TEL.: 252 299 080

Universal Motors UK, Ltd
 Unit E2, Meltham Mills Road
 West Yorkshire HD9 4AR
enquiries@universalmotors-group.co.uk
 TEL.: +44(0) 1484660222

Universal Motors SL
 C/La Habana n.6 nave 4 PI Camporoso
 28806 Alcala de Henares
info@universalmotors-group.es
 TEL.: 918 864 213

PQ63FB... Basic wormbox
Riduttore base

Gearbox weight
peso riduttore **6.00 kg**

M. flanges	Kit code	øF	A
63B5	K063.4.041	140	99.5
71B5	K063.4.042	160	97.5
80/90B5	K063.4.043	200	99.5
71B14	K063.4.047	105	97.5
80B14	K063.4.046	120	99.5
90B14	K063.4.041	140	99.5



PQ63FC... Square flange
Flangia quadrata

PQ63F1... Round flange
Flangia rotonda



type B	øD	E	G	L	N	O	P	Q	kit code
FC	115 ^{+0.20} / _{+0.15}	6	12	86	26	150	180	11	① KQ63.9.010 ② -
FL	115 ^{+0.20} / _{+0.15}	6	12	116	56	150	180	11	① KQ63.9.010 ② K063.0.200

type S	øD	E	G	L	N	O	P	Q	kit code
F1	130 ^{+0.20} / _{+0.15}	7	13	110	50	165	200	13	① KS070.9.013 ② -
F2	115 ^{+0.20} / _{+0.15}	7	13	124	64	150	175	11	① KS063.9.013 ② -
F3	110 ^{+0.035} / ₀	5	11	90	30	130	160	10	① KS063.9.011 ② -

PQ63FB... Feet
Piedini

PQ63BR... Reaction arm
Braccio di reazione



RQ63FB... Input shaft
Albero in entrata

PQ63.....S... Single Shaft
Albero lento semplice

PQ63.....D... Double Shaft
Albero lento bisp.



① kit cod. K063.5.028 type B ② kit cod. K063.5.029 type B

	ød	e	g	l	m	x	kit code
type B	18 h6	20.5	6	45	93	M6x16	① K063.5.006 PAM80 ② K063.5.007 PAM90
type S	19 h6	21.5	6	40	93	M8x20	① KS063.5.008 PAM80 ② KS063.5.009 PAM90

	b1	c1	d1	e1	f1	l1	m1	n1	t2	o1
type B	8	60	25 ^{-0.005} / _{-0.020}	63.2	120	246.4	126.8	190	28	M8x20
type S	-	-	-	-	-	-	-	-	-	-