

Ficha Técnica  
Redutor de Velocidade  
PARAFUSO SEM FIM QUADRADO



MODELO	Q75	
Ø VEIO SAÍDA	30	mm
RÁCIO APROXIMADO	100	
RÁCIO EXATO	100.00	
VELOCIDADE SAÍDA	15	RPM
VELOCIDADE SAÍDA EXATA	15	RPM
POTÊNCIA ENTRADA	0.55	KW
ROTAÇÃO ENTRADA	1400	RPM
PAM ENTRADA	80B14	
TORQUE SAÍDA	206.33	N.m
TORQUE NOMINAL	150.00	N.m
POTÊNCIA NOMINAL	0.4	KW
FATOR SERVIÇO	0.73	
EFICIÊNCIA DINÂMICA	0.55	



QUANTIDADE DE ÓLEO (L)

B3/H1	B6/H4	B7/H3	B8/H2	V5/H5	V6/H6
0.4	0.4	0.4	0.4	0.4	0.4

CARGAS RADIAIS E AXIAIS



$n_2$ [min-1]	FA [N]	FR [N]
200	460	2300
100	560	2800
50	720	3600
15	1000	5000

Universal Motors S.A.  
Rua Comendador Brandão, 484  
4495-375 Póvoa de Varzim  
[geral@universalmotors.pt](mailto:geral@universalmotors.pt)  
TEL.: 252 299 080

Universal Motors UK, Ltd  
Unit E2, Meltham Mills Road  
West Yorkshire HD9 4AR  
[enquiries@universalmotors-group.co.uk](mailto:enquiries@universalmotors-group.co.uk)  
TEL.: +44(0) 1484660222

Universal Motors SL  
C/La Habana n.6 nave 4 PI Camporoso  
28806 Alcala de Henares  
[info@universalmotors-group.es](mailto:info@universalmotors-group.es)  
TEL.: 918 864 213

**PQ75FB...** Basic wormbox  
Riduttore base

Gearbox weight  
peso riduttore **8.70 kg**

M. flanges	Kit code	øF	A
71B5	K023.4.041	160	114
80/90B5	K023.4.042	200	116
100/112B5	K023.4.043	250	125
80B14	K085.4.046	120	116
90B14	K085.4.045	140	116
100/112B14	K085.4.047	160	125



**PQ75FC...** Square flange  
Flangia quadrata

**PQ75FL...** Square flange  
Flangia quadrata

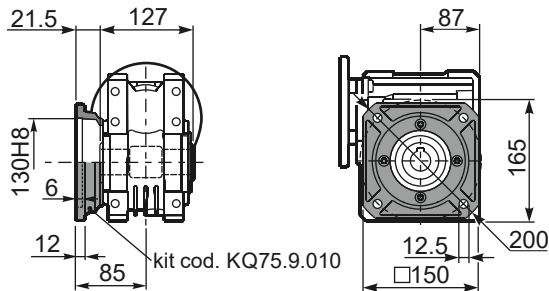

**PQ75FB...** Feet  
Piedini

**PQ75BR...** Reaction arm  
Braccio di reazione

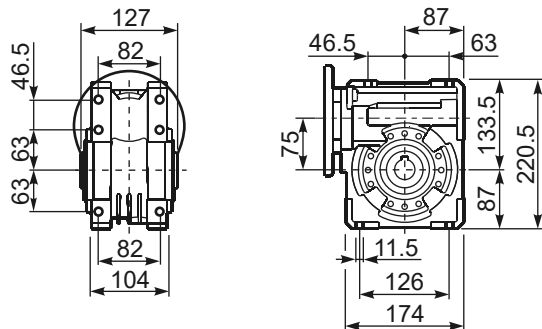

**RQ75FB...** Input shaft  
Albero in entrata

**PQ75....S...** Single Shaft  
Albero lento semplice

**PQ75....D...** Double Shaft  
Albero lento bisp.

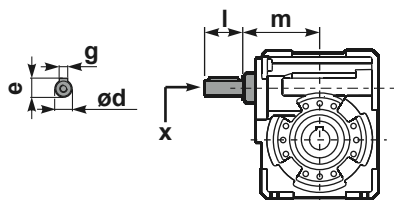

① kit cod. KQ75.5.028 Standard  
kit cod. KQ75.5.026 On request  
② kit cod. KQ75.5.029 Standard

	ød	e	g	l	m	x	kit code
type B	25 h6	27.8	8	50	109.5	M8x20	KQ75.5.006 PAM80 K085.5.007 PAM90 K085.5.008 PAM100

	b1	c1	d1	e1	f1	l1	m1	n1	t2	o1
Standard	8	60	30 <sup>-0.005</sup> <sub>-0.020</sub>	65	127	255	134	199	33	M8x20
On request	8	60	28 <sup>-0.005</sup> <sub>-0.020</sub>	65	-	-	134	199	31	M8x20