

Ficha Técnica
Redutor de Velocidade
PARAFUSO SEM FIM QUADRADO



MODELO	Q85	
Ø VEIO SAÍDA	35	mm
RÁCIO APROXIMADO	10	
RÁCIO EXATO	10.00	
VELOCIDADE SAÍDA	146	RPM
VELOCIDADE SAÍDA EXATA	146	RPM
POTÊNCIA ENTRADA	5.50	KW
ROTAÇÃO ENTRADA	1400	RPM
PAM ENTRADA	112B14	
TORQUE SAÍDA	300.12	N.m
TORQUE NOMINAL	284.00	N.m
POTÊNCIA NOMINAL	5.2	KW
FATOR SERVIÇO	0.95	
EFICIÊNCIA DINÂMICA	0.80	



QUANTIDADE DE ÓLEO (L)

B3/H1	B6/H4	B7/H3	B8/H2	V5/H5	V6/H6
1.2	1.2	1.2	1.2	1.2	1.2

CARGAS RADIAIS E AXIAIS



n_2 [min ⁻¹]	FA [N]	FR [N]
200	500	2500
100	600	3000
50	800	4000
15	1160	5800

Universal Motors S.A.
Rua Comendador Brandão, 484
4495-375 Póvoa de Varzim
geral@universalmotors.pt
TEL.: 252 299 080

Universal Motors UK, Ltd
Unit E2, Meltham Mills Road
West Yorkshire HD9 4AR
enquiries@universalmotors-group.co.uk
TEL.: +44(0) 1484660222

Universal Motors SL
C/La Habana n.6 nave 4 PI Camporoso
28806 Alcala de Henares
info@universalmotors-group.es
TEL.: 918 864 213

PQ85**FB**... Basic wormbox
Riduttore base

Gearbox weight
peso riduttore **12.1 kg**

M. flanges	Kit code	øF	A
71B5	K023.4.041	160	116.5
80/90B5	K023.4.042	200	118.5
100/112B5	K023.4.043	250	127.5
80B14	K085.4.046	120	118.5
90B14	K085.4.045	140	118.5
100/112B14	K085.4.047	160	127.5



PQ85**FC**... Output flange
Flangia uscita

PQ85**F1**... Output flange
Flangia uscita

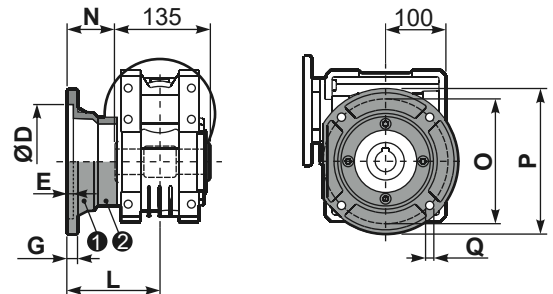
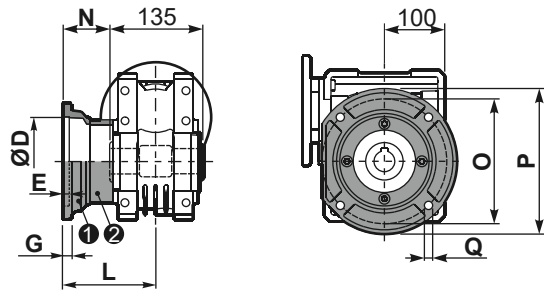

type B	øD	E	G	L	N	O	P	Q	kit code
FC	152 ^{+0.06} / _{+0.00}	5	16	108	40.5	176	205	13	① K085.9.010 ② -
FL	152 ^{+0.06} / _{+0.00}	5	16	148.5	81	176	205	13	① K085.9.010 ② K085.0.201

type S	øD	E	G	L	N	O	P	Q	kit code
F1	130 H7	5	13	117.5	50	165	200	11.5	① KS085.9.012 ② -
F2	152 ^{+0.06} / _{+0.00}	5	15	147.5	80	180	205	12.5	① KS085.9.013 ② -
F4	130 H7	5	13	106.5	39	165	200	13	① KS085.9.015 ② -

PQ85**FB**... Feet
Piedini

PQ85**BR**... Reaction arm
Braccio di reazione

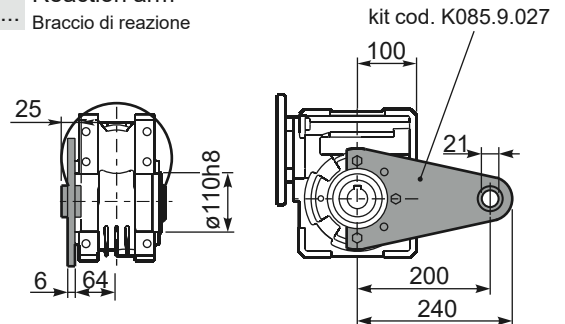
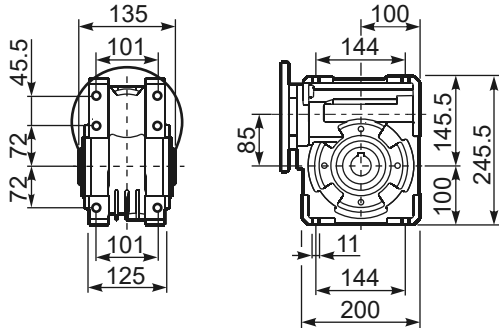

RQ85**FB**... Input shaft
Albero in entrata

PQ85.....**S**... Single Shaft
Albero lento semplice

PQ85.....**D**... Double Shaft
Albero lento bisp.



① kit cod. K085.5.028 type B ② kit cod. K085.5.029 type B

	ød	e	g	l	m	x	kit code
type B	25 h6	28	8	50	112	M8x20	① K085.5.007 PAM90 ② K085.5.008 PAM100
type S	24 h6	27	8	50	112	M8x20	① KS085.5.009 PAM90 ② KS085.5.011 PAM100

	b1	c1	d1	e1	f1	l1	m1	n1	t2	o1
type B	10	60	35 ^{-0.005} / _{-0.020}	73.5	135	282	141	214.5	38	M10x23
type S	-	-	-	-	-	-	-	-	-	-