

Ficha Técnica
Redutor de Velocidade
PARAFUSO SEM FIM QUADRADO



MODELO	Q11	
Ø VEIO SAÍDA	42	mm
RÁCIO APROXIMADO	25	
RÁCIO EXATO	23.00	
VELOCIDADE SAÍDA	58	RPM
VELOCIDADE SAÍDA EXATA	63	RPM
POTÊNCIA ENTRADA	3.00	KW
ROTAÇÃO ENTRADA	1400	RPM
PAM ENTRADA	100 B14	
TORQUE SAÍDA	376.52	N.m
TORQUE NOMINAL	515.00	N.m
POTÊNCIA NOMINAL	4.1	KW
FATOR SERVIÇO	1.37	
EFICIÊNCIA DINÂMICA	0.80	



QUANTIDADE DE ÓLEO (L)

B3/H1	B6/H4	B7/H3	B8/H2	V5/H5	V6/H6
1.9	1.35	1.35	2	2	2

CARGAS RADIAIS E AXIAIS



n_2 [min ⁻¹]	FA [N]	FR [N]
200	600	2900
100	750	3600
50	920	4600
15	1400	7000

Universal Motors S.A.
Rua Comendador Brandão, 484
4495-375 Póvoa de Varzim
geral@universalmotors.pt
TEL.: 252 299 080

Universal Motors UK, Ltd
Unit E2, Meltham Mills Road
West Yorkshire HD9 4AR
enquiries@universalmotors-group.co.uk
TEL.: +44(0) 1484660222

Universal Motors SL
C/La Habana n.6 nave 4 PI Camporoso
28806 Alcalá de Henares
info@universalmotors-group.es
TEL.: 918 864 213

PQ11FB... Basic wormbox
Riduttore base

Gearbox weight
peso riduttore **35.0 kg**

M. flanges	Kit code	øF	A
71B5	K023.4.041	160	136
80/90B5	K023.4.042	200	138
100/112B5	K023.4.043	250	147
132B5	-	300	187
80B14	K085.4.046	120	138
90B14	K085.4.045	140	138
100/112B14	K023.4.041	160	136
132B14	-	200	187



PQ11FC... Output flange
Flangia uscita

PQ11F1... Output flange
Flangia uscita



type B	øD	E	G	L	N	O	P	Q	kit code
FC	170 ^{+0.083} / _{+0.043}	11	16.5	131.5	54	230	270	13	1 K110.9.010 2 -
FL	170 ^{+0.083} / _{+0.043}	11	16.5	179.5	102	230	270	13	1 K110.9.011 2 -

type S	øD	E	G	L	N	O	P	Q	kit code
F1	180 ^{+0.040} / ₀	5	18	150	72.5	215	250	15	1 KS110.9.014 2 -
F3	180 ^{+0.040} / ₀	5	18	130	52.5	215	250	15	1 KS110.9.013 2 -

PQ11FB... Feet
Piedini



PQ11BR... Reaction arm
Braccio di reazione

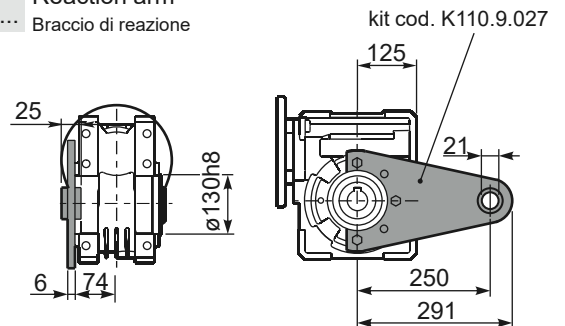

RQ11FB... Input shaft
Albero in entrata

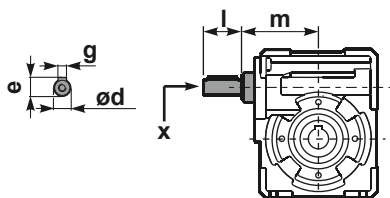

PQ11.....S... Single Shaft
Albero lento semplice

PQ11.....D... Double Shaft
Albero lento bisp.

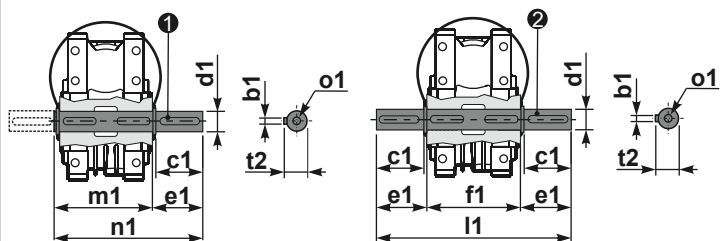

1 kit cod. K110.5.028 type B 2 kit cod. K110.5.029 type B

	ød	e	g	l	m	x	kit code
type B	25 h6	28	8	50	131.5	M8x20	1 K085.5.007 PAM90 2 K085.5.008 PAM100
type S	24 h6	27	8	50	131.5	M8x20	1 KS085.5.009 PAM90 2 KS085.5.011 PAM100

	b1	c1	d1	e1	f1	l1	m1	n1	t2	o1
type B	12	75	42 ^{-0.005} / _{-0.020}	96.5	155	348	163.5	260	45	M12x32
type S	-	-	-	-	-	-	-	-	-	-