

Ficha Técnica  
Redutor de Velocidade  
PARAFUSO SEM FIM QUADRADO



MODELO	M15	
Ø VEIO SAÍDA	50	mm
RÁCIO APROXIMADO	7	
RÁCIO EXATO	7.50	
VELOCIDADE SAÍDA	209	RPM
VELOCIDADE SAÍDA EXATA	195	RPM
POTÊNCIA ENTRADA	11.00	KW
ROTAÇÃO ENTRADA	1400	RPM
PAM ENTRADA	160B5	
TORQUE SAÍDA	512.08	N.m
TORQUE NOMINAL	1200.00	N.m
POTÊNCIA NOMINAL	25.8	KW
FATOR SERVIÇO	2.35	
EFICIÊNCIA DINÂMICA	0.91	



QUANTIDADE DE ÓLEO (L)

B3/H1	B6/H4	B7/H3	B8/H2	V5/H5	V6/H6
7	5.4	5.4	5.1	7	5.1

CARGAS RADIAIS E AXIAIS



$n_2$ [min <sup>-1</sup> ]	FA [N]	FR [N]
200	1300	6500
100	1640	8200
50	2120	10600
15	3300	16500

Universal Motors S.A.  
Rua Comendador Brandão, 484  
4495-375 Póvoa de Varzim  
[geral@universalmotors.pt](mailto:geral@universalmotors.pt)  
TEL.: 252 299 080

Universal Motors UK, Ltd  
Unit E2, Meltham Mills Road  
West Yorkshire HD9 4AR  
[enquiries@universalmotors-group.co.uk](mailto:enquiries@universalmotors-group.co.uk)  
TEL.: +44(0) 1484660222

Universal Motors SL  
C/La Habana n.6 nave 4 PI Camporoso  
28806 Alcalá de Henares  
[info@universalmotors-group.es](mailto:info@universalmotors-group.es)  
TEL.: 918 864 213

PM15**FB**... Basic wormbox  
Riduttore base

Gearbox weight  
peso riduttore **84.0 kg**

M. flanges	Kit code	øF	A
100/112B5	KM15.4.042	250	210
132B5	KM15.4.043	300	210
160B5	KM15.4.044	350	210



PM15**FC**... Square flange  
Flangia quadrata



PM15**FB**... Feet  
Piedini

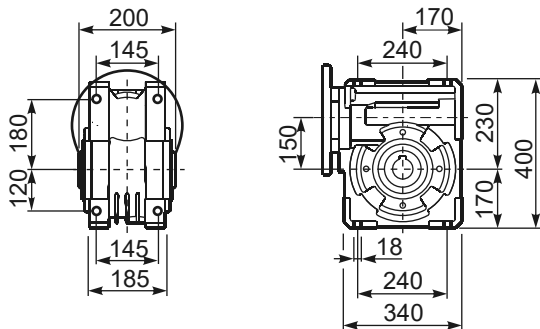

PM15**BR**... Reaction arm  
Braccio di reazione

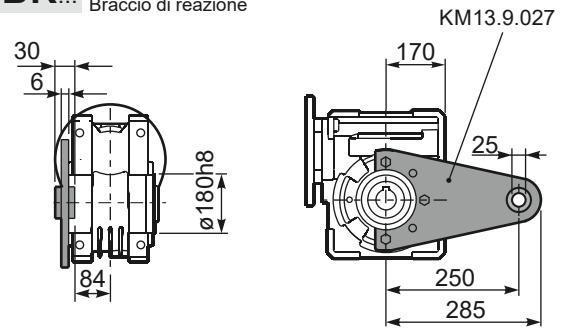

PM15....**S**... Single Shaft  
Albero lento semplice

PM15....**D**... Double Shaft  
Albero lento bisp.

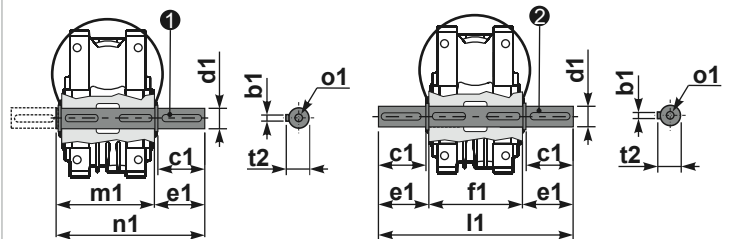

① kit cod. KM15.5.028 type B

② kit cod. KM15.5.029 type B

	b1	c1	d1	e1	f1	l1	m1	n1	t2	o1
type	14	82	50 <sup>-0.005</sup> <sub>-0.020</sub>	87	200	374	210	297	53.5	M16
type	-	-	-	-	-	-	-	-	-	-